

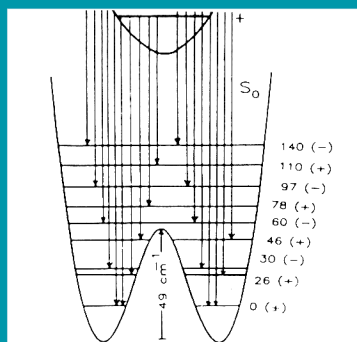

Volume 22 Issue 6

Pages 361–442

December 1993

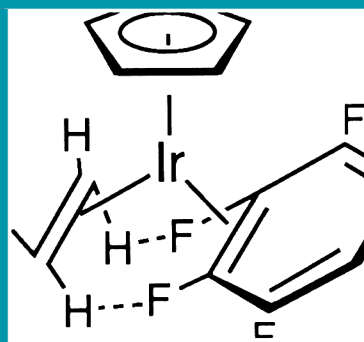

TILDEN LECTURE. Organometallic Intermediates: Ultimate Reagents

By Robin N. Perutz

361

Determination of Molecular Conformation from Large Amplitude Vibrations in Electronic Spectra of Organic Molecules in a Supersonic Jet

By J. Michael Hollas

371

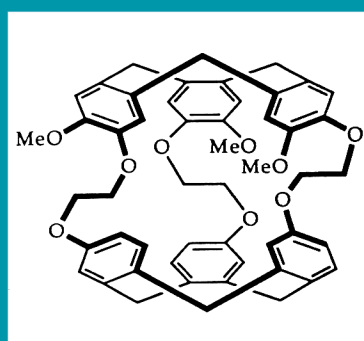

Enantioselective and Diastereoselective Molecular Recognition of Neutral Molecules

By Thomas H. Webb and Craig S. Wilcox

383

The Hydrogen Bond and Crystal Engineering

By Christer B. Aakeröy and Kenneth R. Seddon

397

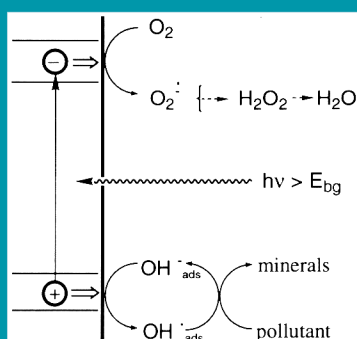
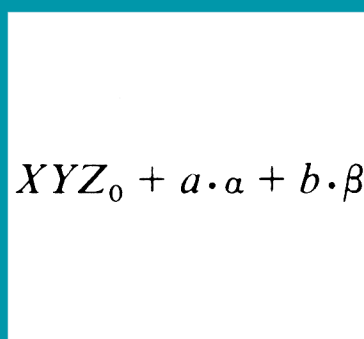

The Properties of Organic Liquids that are Relevant to their Use as Solvating Solvents

By Y. Marcus

409

Water Purification by Semiconductor Photocatalysis

By Andrew Mills, Richard H. Davies, and David Worsley

417

Mechanisms of Solvolytic Alkene-forming Elimination Reactions

By Alf Thibblin

427

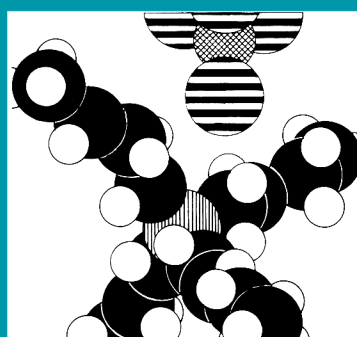
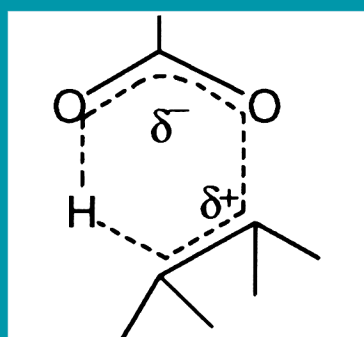

Electrochemistry in Media of Low Dielectric Constant

By Andrew Abbott

435

1993 Indexes

441

Chemical Society Reviews

Editorial Board

Professor H. W. Kroto FRS (Chairman)	University of Sussex
Professor M. J. Blandamer	University of Leicester
Dr. A. R. Butler	University of St. Andrews
Dr. E. C. Constable	University of Cambridge
Professor B. T. Golding	University of Newcastle upon Tyne
Professor M. Green	University of Bath
Professor D. M. P. Mingos FRS	Imperial College London
Professor J. F. Stoddart	University of Birmingham

Consulting Editors

Dr. G. G. Balint-Kurti	University of Bristol
Professor S. A. Benner	Swiss Federal Institute of Technology, Zürich
Dr. J. M. Brown	University of Oxford
Dr. J. Burgess	University of Leicester
Dr. N. Cape	Institute of Terrestrial Ecology, Lothian
Professor A. Hamnett	University of Newcastle upon Tyne
Dr. T. M. Herrington	University of Reading
Professor R. Hillman	University of Leicester
Professor R. Keese	University of Bern
Dr. T. H. Lilley	University of Sheffield
Dr. H. Maskill	University of Newcastle upon Tyne
Professor Dr. A. de Meijere	University of Göttingen
Professor J. N. Miller	Loughborough University of Technology
Professor S. M. Roberts	University of Exeter
Professor B. H. Robinson	University of East Anglia
Dr. A. J. Stace	University of Sussex

Staff Editors

Mr. K. J. Wilkinson	Royal Society of Chemistry, Cambridge
Dr. J. A. Rhodes	Royal Society of Chemistry, Cambridge
Dr. M. Sugden	Royal Society of Chemistry, Cambridge

It is intended that **Chemical Society Reviews** will have the broad appeal necessary for researchers to benefit from an awareness of advances in areas outside their own specialities. Deliberate efforts will be made to solicit authors and articles from Europe which present a truly international outlook on the major advances in a wide range of chemical areas. It is hoped that it will be particularly stimulating and instructive for students planning a career in research. The articles will be succinct and authoritative overviews of timely topics in modern chemistry.

In line with the above, review articles will not be overly comprehensive, detailed, or heavily referenced (*ca.* 30 references), but should act as a springboard to further reading. In general, authors, who will be recognized experts in their fields, will be asked to place any of their own work in the wider context. Review articles must be *short*, around 6–8 journal pages in extent. In consequence, manuscripts should not exceed 20–30 A4/American quarto sheets, this length to include text (in double line spacing), tables, references, and artwork. An Instruction to Authors leaflet is available from the Senior Editor (Reviews).

Although the majority of articles are intended to be specially commissioned, the Society always considers offers of articles for publication. In such cases a short synopsis, rather than the completed article, should be submitted to the Senior Editor (Reviews), Books and Reviews Department, The Royal Society of Chemistry, Thomas Graham House, Science Park, Milton Road, Cambridge CB4 4WF.

© The Royal Society of Chemistry, 1993
All Rights Reserved

No part of this publication may be reproduced, stored in a retrieval system, or transmitted in any form, or by any means, electronic or mechanical, photographic, recording, or otherwise, without the prior permission of the publishers.

Typeset by Servis Filmsetting Ltd.
Printed in Great Britain by
Blackbear Press Ltd.